

the future of space conditioning

Cornice™

active chilled beam

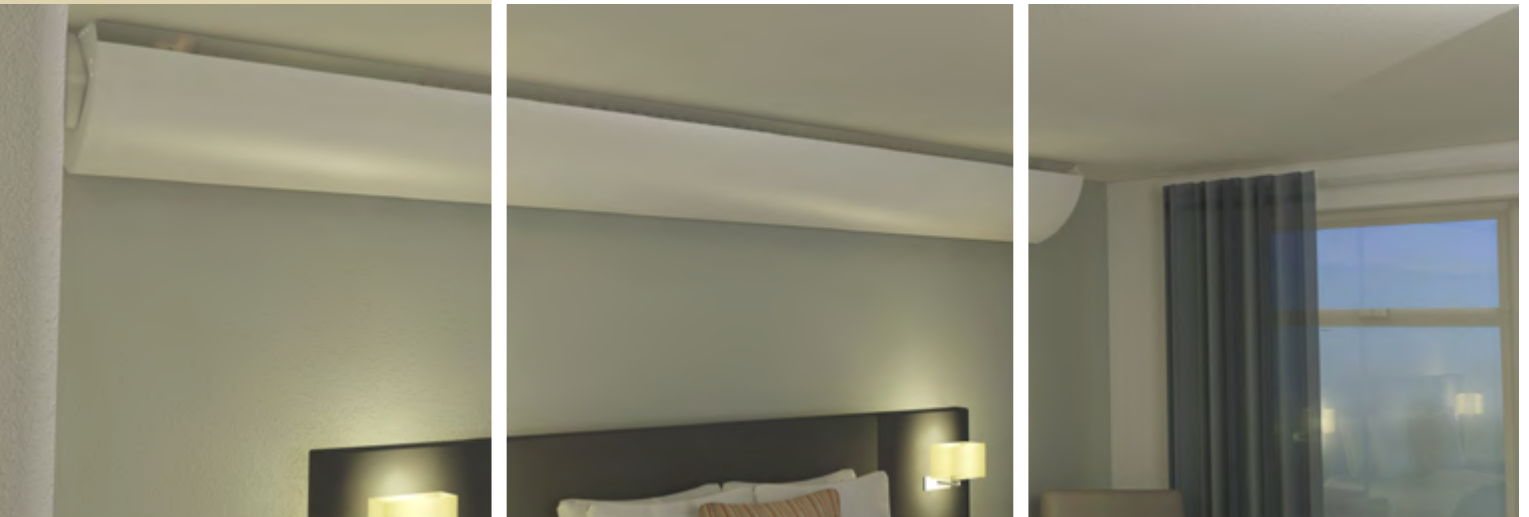





Frenger Systems participates in the ECC program for Chilled Beams. Check ongoing validity of certificate:
www.eurovent-certification.com or
www.certiflash.com 

Contents

Product Description	5
Cooling Performance	6
Heating Performance	7
Cooling Selection Tables	8
Heating Selection Tables	10
Air Cooling Effect	12
Electric Radiant Heating	13
Perforation Pattern Options	14
Lighting Options	15
Product Dimensions	16
Water Connection	17
Mounting Details	18
Cornice Connection Covers	19
Calculation Program	20
Bespoke Manufacturing	21
Project Specific Testing Facility	22
Photometric Testing Facility	23
Acoustic Testing Facility	24

Product Description

Cornice is one of Frenger's latest range of high performance Chilled Beams. Energy efficiency has been a key driver for such advancements in Frenger's Chilled Beam Technology.

Cornice is only **340mm deep** and can achieve **630 watts per active meter total cooling** (based on $10\Delta t_k$ and 16 ltrs / sec / m for a beam supplied at 16°C with a 100Pa).

The Cornice beam contains a number of **Frenger's patented performance enhancing features** and registered designs as can be expected from the Frenger brand. The Cornice beam is designed to be easily tailored to suit the unique parameters of individual project sites, for the optimum product / system efficiencies. This is partly achieved by Frenger's "burst nozzle" arrangement that not only encourages induction, but also reduces noise. Given the size and amount of burst nozzles being appropriately quantified for each project, this provides consistent jet velocities, equal distribution of the air discharge and continuous induction through the heat exchanger (battery). There are no dead spots due to plugging back nozzles from a standard pitch or having to adjust the pressure in the system to suit the amount of open standard nozzle sizes as associated with many competitors' active beams as dead spots and / or reduced jet velocities decrease their cooling capacities / efficiencies.

Frenger's heat exchanger batteries are also fitted with extruded aluminium profiles to not only enhance performance but also provide a continuous clip on facility for the underplates. This arrangement keeps the front fascia true and straight for long lengths, even up to 3.6m.

Cornice can be used in most types of commercial building (such as cellular offices, banks and hospitals) but are most suited to "Hotel Applications" with its facility to discreetly nestle in the corner along a back wall, usually directly above the bed location with optional features such as:

- LED lighting - see page 14.
- Condensation tray - see page 14.
- Electric Radiant Heating - see page 12.

All induced / recirculated room air is via Frenger's unique air intake which conceals the inside workings of the active beam even when viewed from directly below, whilst an occupant is resting in bed for example. This is a "Registered Community Design" feature by Frenger along with the other features and Patented performance enhancing components.

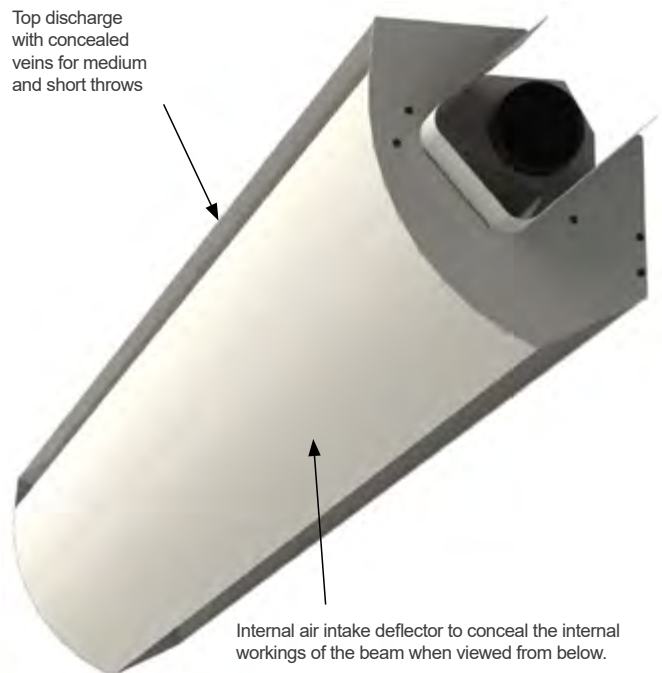

Cornice discharges its reconditioned air (which is a mixture of circa 20% fresh air and 80% recirculated air) at high level out of the top of the unit which then entrains across the ceiling before gently dispersing and mixing with the room air.

Cornice can have a variety of different front fascias for different aesthetics. The front fascia is easily removable for cleaning purposes and / or access to the control valves which are neatly concealed behind the removable main front fascia or a separate removable short length fascia.

Cornice is available in any length from 1.8m up to 3.6m in 100mm increments and has another useful design feature of "telescopic" extension ends from the end gables to "fine tune" onsite a "Wall to Wall" installation.

At a glance

- Telescopic ends for full "Wall to Wall" installation.
- Controls are (factory fitted or site fitted) concealed behind easily removable front fascia panel.
- LED Lighting can be incorporated within the Cornice unit as an optional extra.
- Different front fascia designs (perforations) are available for Cornice.
- L.T.H.W heating function (4 pipe) is available.
- Electric Radiant Heating to the main front fascia available.
- Acoustic options for sound reducing material to be added can be accommodated for "silent nights".
- Air deflector on air intake for concealed internal components of the active beam for improved aesthetics when viewed from below.

Cooling Performance

Cornice Waterside Cooling Effect at 9.0 dTK
 (Primary Air = 80Pa, Chilled Water = 14/17°C, Room Condition = 24.5°C)

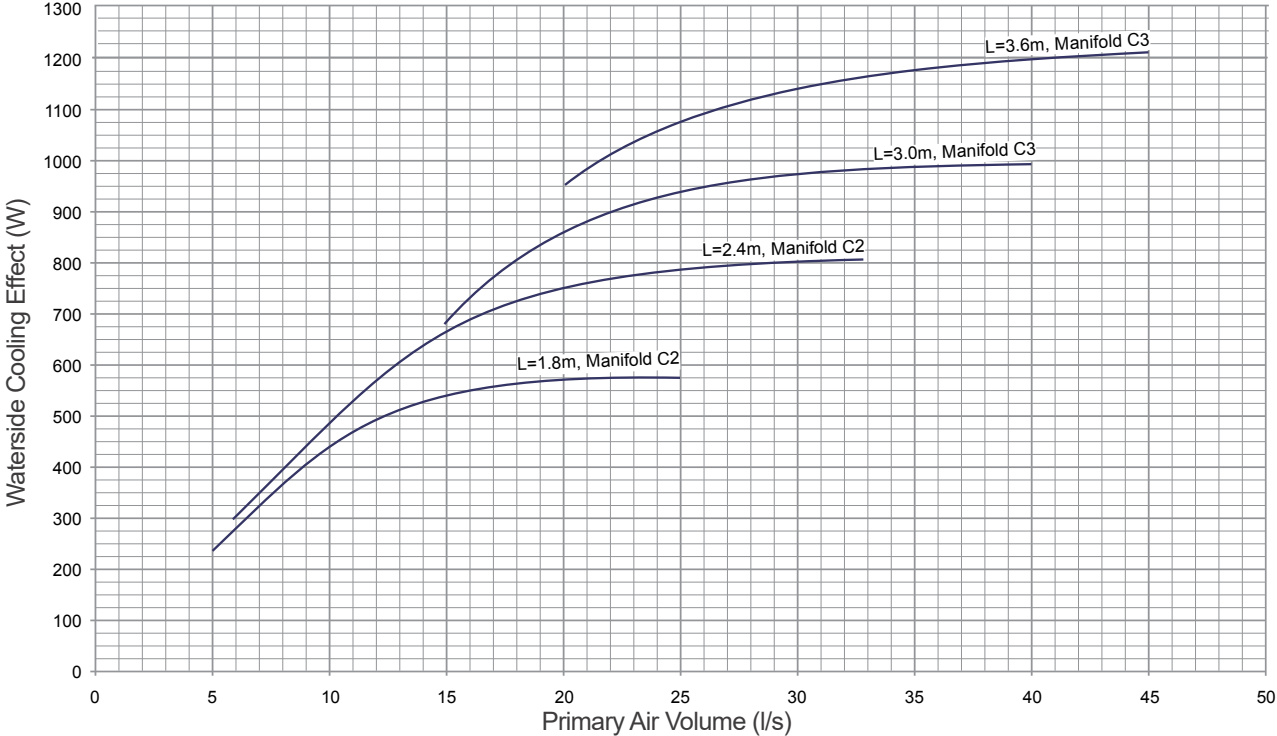

Cooling figures are based on a cooling & heating beam, additional cooling is possible with a cooling only product - contact Frenger for more information

Pressure Drop

Cornice Chilled Water Pressure Drop

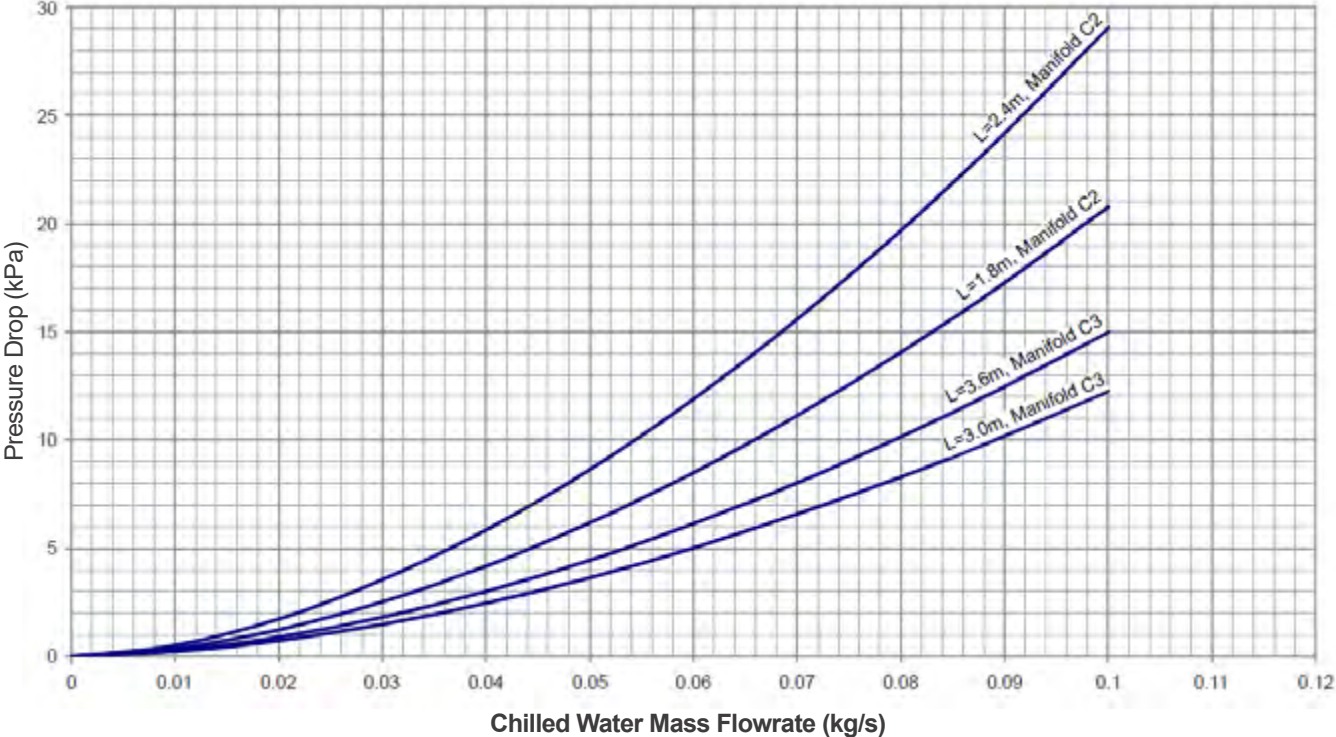

Heating Performance

Cornice Waterside Heating Effect at 24.0 dTk
(Primary Air = 80Pa, Heating Water = 50/40°C, Room Condition = 21°C)

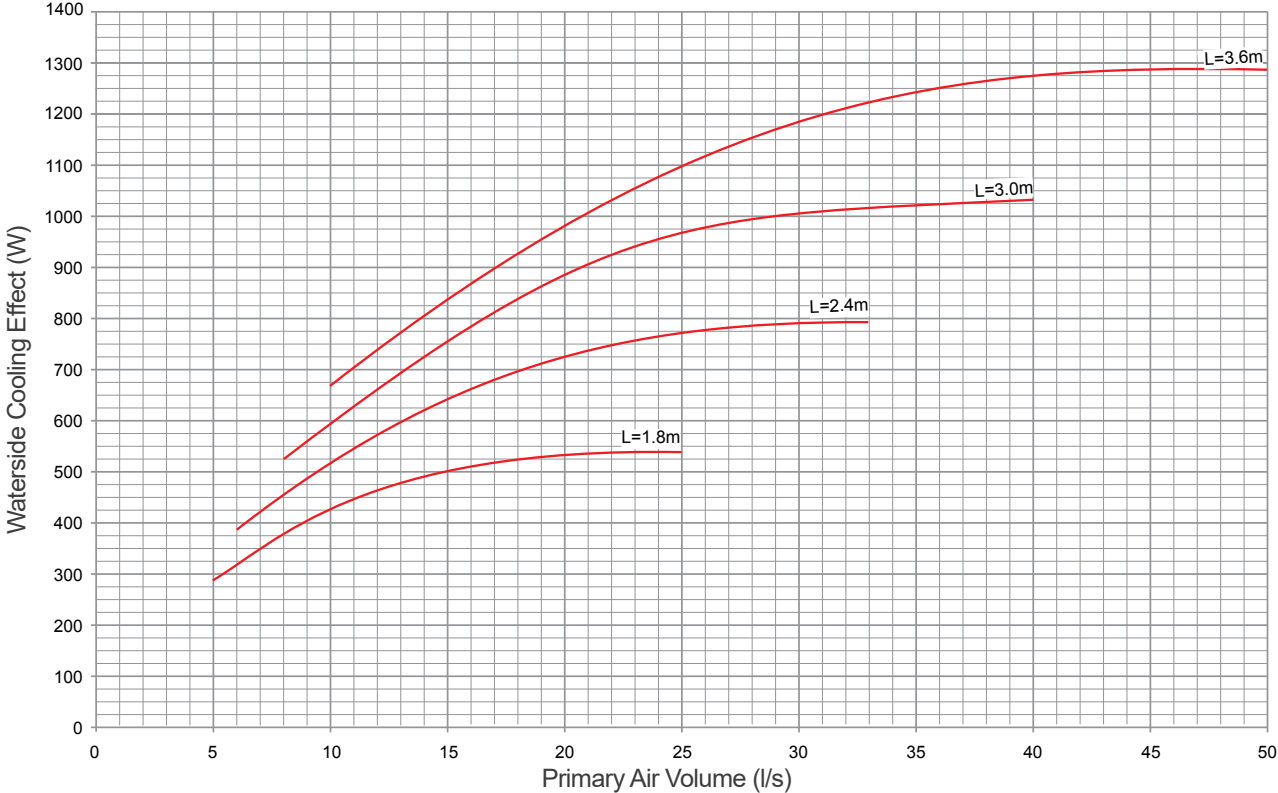

Pressure Drop

Cornice Heating Water Pressure Drop

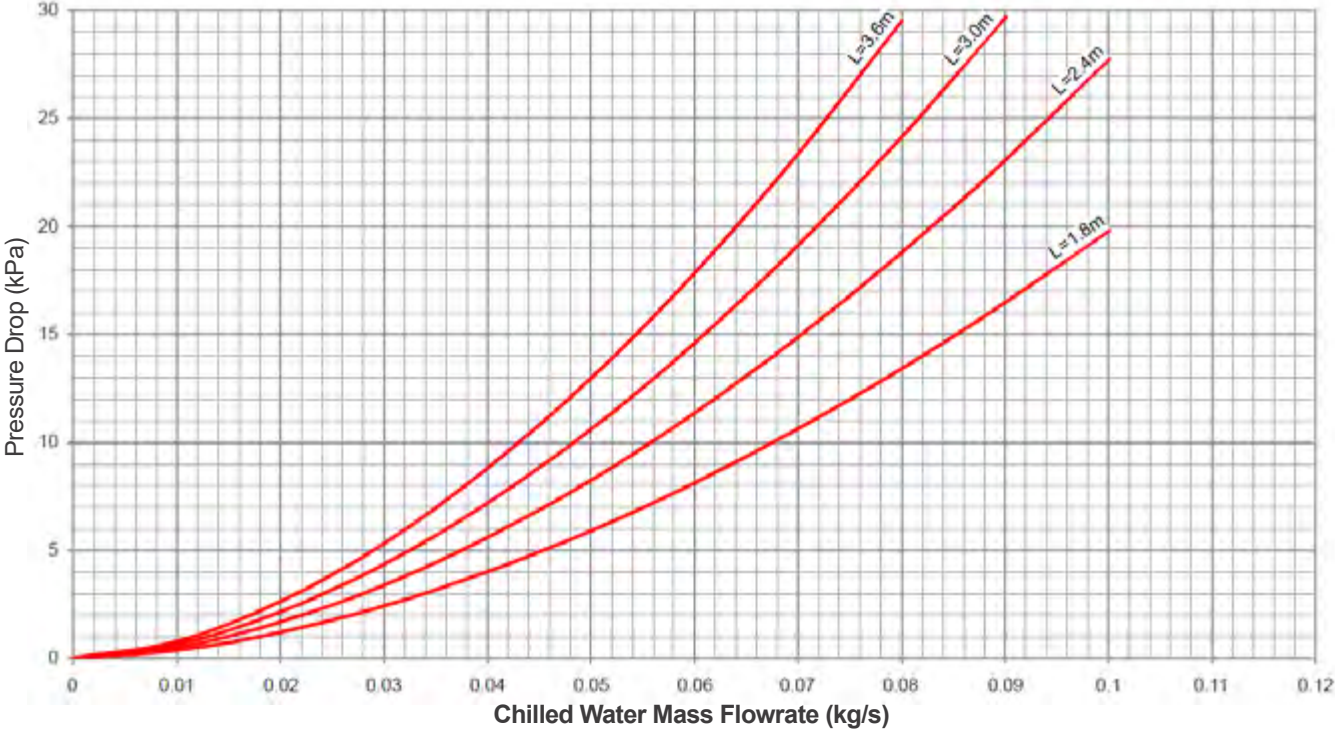

Cooling Selection Tables

Cooling at 40Pa Nozzle Pressure

Nozzle Pressure 40 Pa		Water															
Q (l/s)	Cornice L (m)	$\Delta tK - 7^{\circ}C$				$\Delta tK - 8^{\circ}C$				$\Delta tK - 9^{\circ}C$				$\Delta tK - 10^{\circ}C$			
		P (w)	p(kg/s)	Manifold	p(kPa)	P (w)	p(kg/s)	Manifold	p(kPa)	P (w)	p(kg/s)	Manifold	p(kPa)	P (w)	p(kg/s)	Manifold	p(kPa)
5	1.8	156	0.019	C3	0.6	179	0.021	C3	0.7	203	0.024	C3	0.9	227	0.027	C3	1.1
	2.4	156	0.019	C3	0.8	178	0.021	C3	1.0	202	0.024	C3	1.2	225	0.027	C3	1.5
	3.0	163	0.019	C3	1.9	187	0.022	C3	1.4	211	0.025	C3	1.7	235	0.027	C3	2.0
	3.6	-	-	-	-	-	-	-	-	-	-	-	-	-	-	-	-
10	1.8	231	0.028	C3	1.1	267	0.032	C3	1.4	304	0.036	C3	1.8	342	0.041	C3	2.2
	2.4	308	0.037	C3	2.6	356	0.043	C3	3.3	406	0.048	C3	4.1	456	0.054	C3	5.0
	3.0	337	0.040	C3	3.8	390	0.047	C3	4.9	443	0.053	C3	6.1	498	0.059	C3	7.5
	3.6	339	0.041	C3	4.7	392	0.047	C3	6.0	445	0.053	C3	7.5	499	0.060	C3	9.2
15	1.8	-	-	-	-	-	-	-	-	-	-	-	-	-	-	-	-
	2.4	341	0.041	C3	3.1	395	0.047	C3	3.9	450	0.054	C3	4.9	506	0.060	C3	6.0
	3.0	437	0.052	C3	6.0	506	0.060	C3	7.7	575	0.069	C3	9.6	645	0.077	C3	11.7
	3.6	504	0.060	C3	9.3	583	0.070	C3	12.0	662	0.079	C3	14.9	741	0.088	C3	18.2
20	1.8	-	-	-	-	-	-	-	-	-	-	-	-	-	-	-	-
	2.4	-	-	-	-	-	-	-	-	-	-	-	-	-	-	-	-
	3.0	459	0.055	C3	6.5	531	0.063	C3	8.4	603	0.072	C3	10.4	676	0.081	C3	12.7
	3.6	559	0.067	C3	11.1	646	0.077	C3	14.3	732	0.087	C3	17.8	790	0.094	C4	10.3

Flow-adjusted waterside cooling effect table. Cooling circuit $\Delta t = 2^{\circ}C$ (Water in-out), nozzle pressure of 40 Pa, 1 x $\varnothing 100$ air connection.
Please refer to Frenger Technical Department for selections not covered within these tables.

Cooling at 60Pa Nozzle Pressure

Nozzle Pressure 60 Pa		Water															
Q (l/s)	Cornice L (m)	$\Delta tK - 7^{\circ}C$				$\Delta tK - 8^{\circ}C$				$\Delta tK - 9^{\circ}C$				$\Delta tK - 10^{\circ}C$			
		P (w)	p(kg/s)	Manifold	p(kPa)	P (w)	p(kg/s)	Manifold	p(kPa)	P (w)	p(kg/s)	Manifold	p(kPa)	P (w)	p(kg/s)	Manifold	p(kPa)
5	1.8	152	0.018	C3	0.5	175	0.021	C3	0.7	199	0.024	C3	0.9	223	0.027	C3	1.1
	2.4	167	0.020	C3	0.9	192	0.023	C3	1.1	217	0.026	C3	1.4	243	0.029	C3	1.7
	3.0	-	-	-	-	-	-	-	-	-	-	-	-	-	-	-	-
	3.6	-	-	-	-	-	-	-	-	-	-	-	-	-	-	-	-
10	1.8	279	0.033	C3	1.6	325	0.039	C3	2.0	373	0.044	C3	2.4	421	0.050	C3	3.2
	2.4	329	0.039	C3	2.9	382	0.046	C3	3.7	437	0.052	C3	4.7	492	0.059	C3	5.7
	3.0	335	0.040	C3	3.8	388	0.046	C3	4.9	442	0.053	C3	6.1	497	0.059	C3	7.5
	3.6	338	0.040	C3	4.7	390	0.047	C3	6.0	444	0.053	C3	7.5	498	0.059	C3	9.1
15	1.8	289	0.034	C3	1.7	337	0.040	C3	2.2	387	0.046	C3	2.7	437	0.052	C3	3.4
	2.4	425	0.051	C3	4.5	495	0.059	C3	5.8	565	0.068	C3	7.3	636	0.076	C3	8.9
	3.0	509	0.061	C3	7.8	591	0.071	C3	10.0	672	0.080	C3	12.5	754	0.090	C3	15.3
	3.6	536	0.064	C3	10.3	620	0.074	C3	13.3	704	0.084	C3	16.6	758	0.090	C4	9.5
20	1.8	-	-	-	-	-	-	-	-	-	-	-	-	-	-	-	-
	2.4	429	0.051	C3	4.5	500	0.060	C3	5.9	572	0.068	C3	7.4	644	0.077	C3	9.1
	3.0	575	0.069	C3	9.6	666	0.080	C3	12.3	757	0.090	C3	15.4	848	0.101	C3	18.8
	3.6	680	0.081	C3	15.6	785	0.094	C3	20.0	856	0.102	C4	11.7	961	0.115	C4	14.4

Flow-adjusted waterside cooling effect table. Cooling circuit $\Delta t = 2^{\circ}C$ (Water in-out), nozzle pressure of 60 Pa, 1 x $\varnothing 100$ air connection.
Please refer to Frenger Technical Department for selections not covered within these tables.

Cooling at 80Pa Nozzle Pressure

Nozzle Pressure 80 Pa		Water															
Q (l/s)	Cornice L (m)	$\Delta tK - 7^{\circ}C$				$\Delta tK - 8^{\circ}C$				$\Delta tK - 9^{\circ}C$				$\Delta tK - 10^{\circ}C$			
		P (w)	p(kg/s)	Manifold	p(kPa)	P (w)	p(kg/s)	Manifold	p(kPa)	P (w)	p(kg/s)	Manifold	p(kPa)	P (w)	p(kg/s)	Manifold	p(kPa)
5	1.8	156	0.019	C3	0.6	180	0.021	C3	0.7	205	0.024	C3	0.9	230	0.027	C3	1.1
	2.4	-	-	-	-	-	-	-	-	-	-	-	-	-	-	-	-
	3.0	-	-	-	-	-	-	-	-	-	-	-	-	-	-	-	-
	3.6	-	-	-	-	-	-	-	-	-	-	-	-	-	-	-	-
10	1.8	289	0.034	C3	1.7	339	0.041	C3	2.2	392	0.047	C3	2.8	445	0.053	C3	3.5
	2.4	331	0.039	C3	2.9	386	0.046	C3	3.8	442	0.053	C3	4.8	500	0.060	C3	5.9
	3.0	340	0.041	C3	3.9	395	0.047	C3	5.0	450	0.054	C3	6.3	506	0.060	C3	7.7
	3.6	358	0.043	C3	5.2	414	0.049	C3	6.7	472	0.056	C3	8.3	529	0.063	C3	10.1
15	1.8	315	0.038	C3	1.9	371	0.044	C3	2.4	429	0.051	C3	3.3	488	0.058	C3	4.0
	2.4	455	0.054	C3	5.0	533	0.064	C3	6.5	611	0.073	C3	8.3	689	0.082	C3	10.2
	3.0	527	0.063	C3	8.2	613	0.073	C3	10.6	699	0.084	C3	13.4	785	0.094	C3	16.4
	3.6	543	0.065	C3	10.6	629	0.075	C3	13.6	715	0.085	C3	17.0	768	0.092	C4	9.7
20	1.8	-	-	-	-	-	-	-	-	-	-	-	-	-	-	-	-
	2.4	478	0.057	C3	5.4	560	0.067	C3	7.1	642	0.077	C3	9.0	723	0.086	C3	11.0
	3.0	626	0.075	C3	11.0	727	0.087	C3	14.2	826	0.099	C3	17.8	867	0.106	C4	10.2
	3.6	719	0.086	C3	17.0	790	0.094	C4	10.2	904	0.108	C4	12.8	1016	0.121	C4	15.7

Flow-adjusted waterside cooling effect table. Cooling circuit $\Delta t = 2^{\circ}C$ (Water in-out), nozzle pressure of 80 Pa, 1 x $\varnothing 100$ air connection.
Please refer to Frenger Technical Department for selections not covered within these tables.

Cooling at 100Pa Nozzle Pressure

Nozzle Pressure 100 Pa		Water															
Q (l/s)	Cornice L (m)	$\Delta tK - 7^{\circ}C$				$\Delta tK - 8^{\circ}C$				$\Delta tK - 9^{\circ}C$				$\Delta tK - 10^{\circ}C$			
		P (w)	p(kg/s)	Manifold	p(kPa)	P (w)	p(kg/s)	Manifold	p(kPa)	P (w)	p(kg/s)	Manifold	p(kPa)	P (w)	p(kg/s)	Manifold	p(kPa)
5	1.8	169	0.020	C3	0.7	195	0.023	C3	0.8	222	0.027	C3	1.1	249	0.030	C3	1.3
	2.4	-	-	-	-	-	-	-	-	-	-	-	-	-	-	-	-
	3.0	-	-	-	-	-	-	-	-	-	-	-	-	-	-	-	-
	3.6	-	-	-	-	-	-	-	-	-	-	-	-	-	-	-	-
10	1.8	322	0.038	C3	2.0	376	0.045	C3	2.6	431	0.051	C3	3.3	486	0.058	C3	4.0
	2.4	356	0.043	C3	3.3	414	0.049	C3	4.3	472	0.056	C3	5.3	531	0.063	C3	6.5
	3.0	365	0.044	C3	4.4	422	0.050	C3	5.6	481	0.057	C3	7.1	540	0.064	C3	8.6
	3.6	389	0.046	C3	6.0	450	0.054	C3	7.7	511	0.061	C3	9.6	572	0.068	C3	11.6
15	1.8	354	0.042	C3	2.4	415	0.050	C3	3.1	477	0.057	C3	3.9	539	0.064	C3	4.8
	2.4	501	0.060	C3	5.9	582	0.069	C3	7.6	663	0.079	C3	9.6	744	0.089	C3	11.7
	3.0	563	0.067	C3	9.2	651	0.078	C3	11.9	739	0.088	C3	14.8	826	0.099	C3	18.0
	3.6	575	0.069	C3	11.7	663	0.079	C3	15.0	751	0.090	C3	18.6	812	0.097	C4	10.8
20	1.8	-	-	-	-	-	-	-	-	-	-	-	-	-	-	-	-
	2.4	531	0.063	C3	6.5	618	0.074	C3	8.4	705	0.084	C3	10.6	791	0.094	C3	13.0
	3.0	681	0.081	C3	12.8	786	0.094	C3	16.4	857	0.102	C4	9.6	962	0.115	C4	11.8
	3.6	763	0.091	C3	19.1	846	0.101	C4	11.5	961	0.115	C4	14.4	1076	0.129	C4	17.5

Flow-adjusted waterside cooling effect table. Cooling circuit $\Delta t = 2^{\circ}C$ (Water in-out), nozzle pressure of 100 Pa, 1 x $\varnothing 100$ air connection.
Please refer to Frenger Technical Department for selections not covered within these tables.

Heating Selection Tables

Heating at 40Pa Nozzle Pressure

Nozzle Pressure 40 Pa		Water											
Q (l/s)	Comice	$\Delta tK - 20^{\circ}C$			$\Delta tK - 25^{\circ}C$			$\Delta tK - 30^{\circ}C$			$\Delta tK - 35^{\circ}C$		
	L (m)	P (w)	p(kg/s)	p(kPa)	P (w)	p(kg/s)	p(kPa)	P (w)	p(kg/s)	p(kPa)	P (w)	p(kg/s)	p(kPa)
5	1.8	165	0.012	1.0	205	0.012	1.1	239	0.012	0.9	285	0.014	1.2
	2.4	196	0.012	1.5	239	0.012	1.4	289	0.014	1.7	345	0.017	2.3
	3.0	221	0.013	1.9	272	0.013	2.0	335	0.016	2.8	398	0.019	3.8
	3.6	-	-	-	-	-	-	-	-	-	-	-	-
10	1.8	216	0.012	1.0	271	0.013	1.1	340	0.016	1.6	409	0.020	2.2
	2.4	263	0.013	1.5	345	0.017	2.4	428	0.020	3.4	511	0.024	4.6
	3.0	309	0.015	2.6	402	0.019	4.0	495	0.024	5.6	587	0.028	7.5
	3.6	348	0.017	3.9	449	0.022	5.9	551	0.026	8.3	651	0.031	11.0
15	1.8	-	-	-	-	-	-	-	-	-	-	-	-
	2.4	318	0.015	2.1	417	0.020	3.3	516	0.025	4.7	614	0.029	6.3
	3.0	386	0.018	3.8	500	0.024	5.9	614	0.029	8.2	726	0.035	10.9
	3.6	438	0.021	5.8	565	0.027	8.9	690	0.033	12.3	814	0.039	16.2
20	1.8	-	-	-	-	-	-	-	-	-	-	-	-
	2.4	-	-	-	-	-	-	-	-	-	-	-	-
	3.0	434	0.021	4.7	562	0.027	7.2	688	0.033	10.0	811	0.039	13.2
	3.6	507	0.024	7.5	650	0.031	11.3	791	0.038	15.6	931	0.045	20.4

Flow-adjusted worldwide heating effect table. Heating circuit $\Delta t = 5^{\circ}C$ (Water in-out), nozzle pressure of 40 Pa, 1 x \varnothing 100 air connection.
 For red values, the flow rate has been adjusted to the recommended minimum flow of 0.012 kg/s.

Heating at 60Pa Nozzle Pressure

Nozzle Pressure 60 Pa		Water											
Q (l/s)	Comice	$\Delta tK - 20^{\circ}C$			$\Delta tK - 25^{\circ}C$			$\Delta tK - 30^{\circ}C$			$\Delta tK - 35^{\circ}C$		
	L (m)	P (w)	p(kg/s)	p(kPa)	P (w)	p(kg/s)	p(kPa)	P (w)	p(kg/s)	p(kPa)	P (w)	p(kg/s)	p(kPa)
5	1.8	167	0.012	0.9	211	0.013	1.1	262	0.016	1.5	314	0.019	2.1
	2.4	200	0.012	1.4	259	0.016	2.1	320	0.019	3.0	381	0.023	4.0
	3.0	-	-	-	-	-	-	-	-	-	-	-	-
	3.6	-	-	-	-	-	-	-	-	-	-	-	-
10	1.8	232	0.014	1.3	306	0.018	2.1	379	0.023	2.9	453	0.027	3.9
	2.4	293	0.018	2.7	380	0.023	4.2	467	0.028	5.9	553	0.033	7.8
	3.0	341	0.020	4.5	439	0.026	6.9	535	0.032	9.5	631	0.038	12.5
	3.6	382	0.023	6.8	489	0.029	10.1	594	0.036	13.9	698	0.042	18.2
15	1.8	261	0.016	1.6	345	0.021	2.5	428	0.026	3.6	511	0.031	4.9
	2.4	358	0.021	3.9	463	0.028	5.9	567	0.034	8.2	669	0.040	10.8
	3.0	425	0.025	6.7	544	0.033	10.0	661	0.040	13.8	778	0.047	18.0
	3.6	477	0.029	10.0	608	0.036	14.8	736	0.044	20.3	860	0.049	24.2
20	1.8	-	-	-	-	-	-	-	-	-	-	-	-
	2.4	389	0.023	4.5	503	0.030	6.8	615	0.037	9.5	725	0.043	12.5
	3.0	483	0.029	8.3	617	0.037	12.5	748	0.045	17.1	873	0.049	19.9
	3.6	552	0.033	12.9	701	0.042	19.0	846	0.049	24.5	978	0.049	24.2

Flow-adjusted worldwide heating effect table. Heating circuit $\Delta t = 5^{\circ}C$ (Water in-out), nozzle pressure of 60 Pa, 1 x \varnothing 100 air connection.
 For red values, the flow rate has been adjusted to the recommended minimum flow of 0.012 kg/s.
 For purple values, the flow rate has been adjusted to the recommended maximum flow of 0.049 kg/s.

Heating at 80Pa Nozzle Pressure

Nozzle Pressure 80 Pa		Water											
Q (l/s)	Comice	ΔtK - 20°C			ΔtK - 25°C			ΔtK - 30°C			ΔtK - 35°C		
	L (m)	P (w)	p(kg/s)	p(kPa)	P (w)	p(kg/s)	p(kPa)	P (w)	p(kg/s)	p(kPa)	P (w)	p(kg/s)	p(kPa)
5	1.8	176	0.012	1.0	223	0.013	1.2	277	0.017	1.7	332	0.020	2.3
	2.4	-	-	-	-	-	-	-	-	-	-	-	-
	3.0	-	-	-	-	-	-	-	-	-	-	-	-
	3.6	-	-	-	-	-	-	-	-	-	-	-	-
10	1.8	248	0.015	1.5	326	0.020	2.3	404	0.024	3.3	481	0.029	4.4
	2.4	310	0.019	3.0	402	0.024	4.6	492	0.029	6.4	582	0.035	8.5
	3.0	360	0.022	5.0	463	0.028	7.5	563	0.034	10.4	663	0.040	13.6
	3.6	405	0.024	7.5	517	0.031	11.2	627	0.038	15.3	735	0.044	19.9
15	1.8	289	0.017	1.9	382	0.023	3.0	474	0.028	4.3	565	0.034	5.8
	2.4	383	0.023	4.3	494	0.030	6.6	604	0.036	9.2	712	0.043	12.1
	3.0	449	0.027	7.3	574	0.034	11.0	697	0.042	15.1	821	0.049	19.8
	3.6	503	0.030	10.9	639	0.038	16.2	773	0.046	22.1	899	0.049	24.2
20	1.8	-	-	-	-	-	-	-	-	-	-	-	-
	2.4	428	0.026	5.3	553	0.033	8.1	675	0.040	11.2	795	0.048	14.6
	3.0	517	0.031	9.4	659	0.039	14.0	800	0.048	19.2	927	0.049	19.7
	3.6	585	0.035	14.2	742	0.044	21.0	890	0.049	24.6	1029	0.049	24.2

Flow-adjusted waterside heating effect table. Heating circuit Δt = 5°C (Water in-out), nozzle pressure of 80 Pa, 1 x Ø100 air connection.

For red values, the flow rate has been adjusted to the recommended minimum flow of 0.012 kg/s.

For purple values, the flow rate has been adjusted to the recommended maximum flow of 0.049 kg/s.

Heating at 100Pa Nozzle Pressure

Nozzle Pressure 100 Pa		Water											
Q (l/s)	Comice	ΔtK - 20°C			ΔtK - 25°C			ΔtK - 30°C			ΔtK - 35°C		
	L (m)	P (w)	p(kg/s)	p(kPa)	P (w)	p(kg/s)	p(kPa)	P (w)	p(kg/s)	p(kPa)	P (w)	p(kg/s)	p(kPa)
5	1.8	180	0.012	1.0	228	0.014	1.2	283	0.017	1.8	340	0.020	2.4
	2.4	-	-	-	-	-	-	-	-	-	-	-	-
	3.0	-	-	-	-	-	-	-	-	-	-	-	-
	3.6	-	-	-	-	-	-	-	-	-	-	-	-
10	1.8	255	0.015	1.5	333	0.020	2.4	412	0.025	3.4	490	0.029	4.5
	2.4	316	0.019	3.1	409	0.024	4.7	501	0.030	6.6	592	0.035	8.7
	3.0	368	0.022	5.2	472	0.028	7.8	576	0.034	10.8	677	0.041	14.1
	3.6	415	0.025	7.8	531	0.032	11.7	644	0.039	16.0	756	0.045	20.9
15	1.8	305	0.018	2.1	400	0.024	3.3	495	0.030	4.7	587	0.035	6.2
	2.4	392	0.023	4.5	504	0.030	6.9	615	0.037	9.5	724	0.043	12.4
	3.0	457	0.027	7.6	583	0.035	11.3	708	0.042	15.5	830	0.049	19.7
	3.6	512	0.031	11.2	650	0.039	16.7	786	0.047	22.7	913	0.049	24.2
20	1.8	-	-	-	-	-	-	-	-	-	-	-	-
	2.4	446	0.027	5.7	573	0.034	8.6	697	0.063	11.8	820	0.049	15.5
	3.0	528	0.032	9.7	671	0.040	14.5	813	0.049	19.8	941	0.049	19.7
	3.6	594	0.036	14.6	752	0.045	21.5	900	0.049	24.5	1041	0.049	24.2

Flow-adjusted waterside heating effect table. Heating circuit Δt = 5°C (Water in-out), nozzle pressure of 100 Pa, 1 x Ø100 air connection.

For red values, the flow rate has been adjusted to the recommended minimum flow of 0.012 kg/s.

For purple values, the flow rate has been adjusted to the recommended maximum flow of 0.049 kg/s.

Air Cooling Effect

Cooling effect supplied in the ventilation air [W]

1. Start by calculating the required cooling effect that has to be supplied to the room in order to provide a certain temperature.
2. Calculate any cooling effect that is provided by the ventilation air.
3. The remaining cooling effect has to be supplied by the beam.

Formula for air cooling: $P = m \times C_p \times \Delta t$

Where:

m = mass flow [kg/s]

C_p = specific heat capacity [J/(kg·K)]

q_p = air flow [l/s]

Δt = the difference between the temperature of the room and the temperature of the supply air [K].

It is usually $m \times C_p \approx q_p \times 1.2$

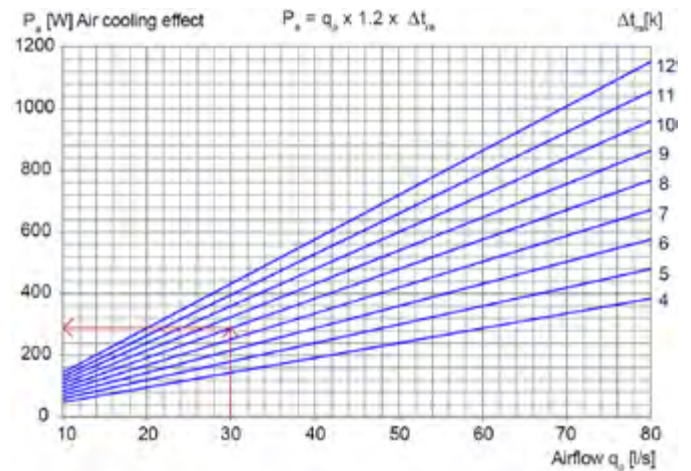

Air cooling effect as a function of airflow. For example, if the air flow is 30 l/s and the under-temperature of the supply air is $\Delta t_{ra} = 8K$, the cooling effect from the graph is 290W.

Scatter Diagram

Fresh Air Volume 16 l/s/m @ 80Pa (Short Throw)

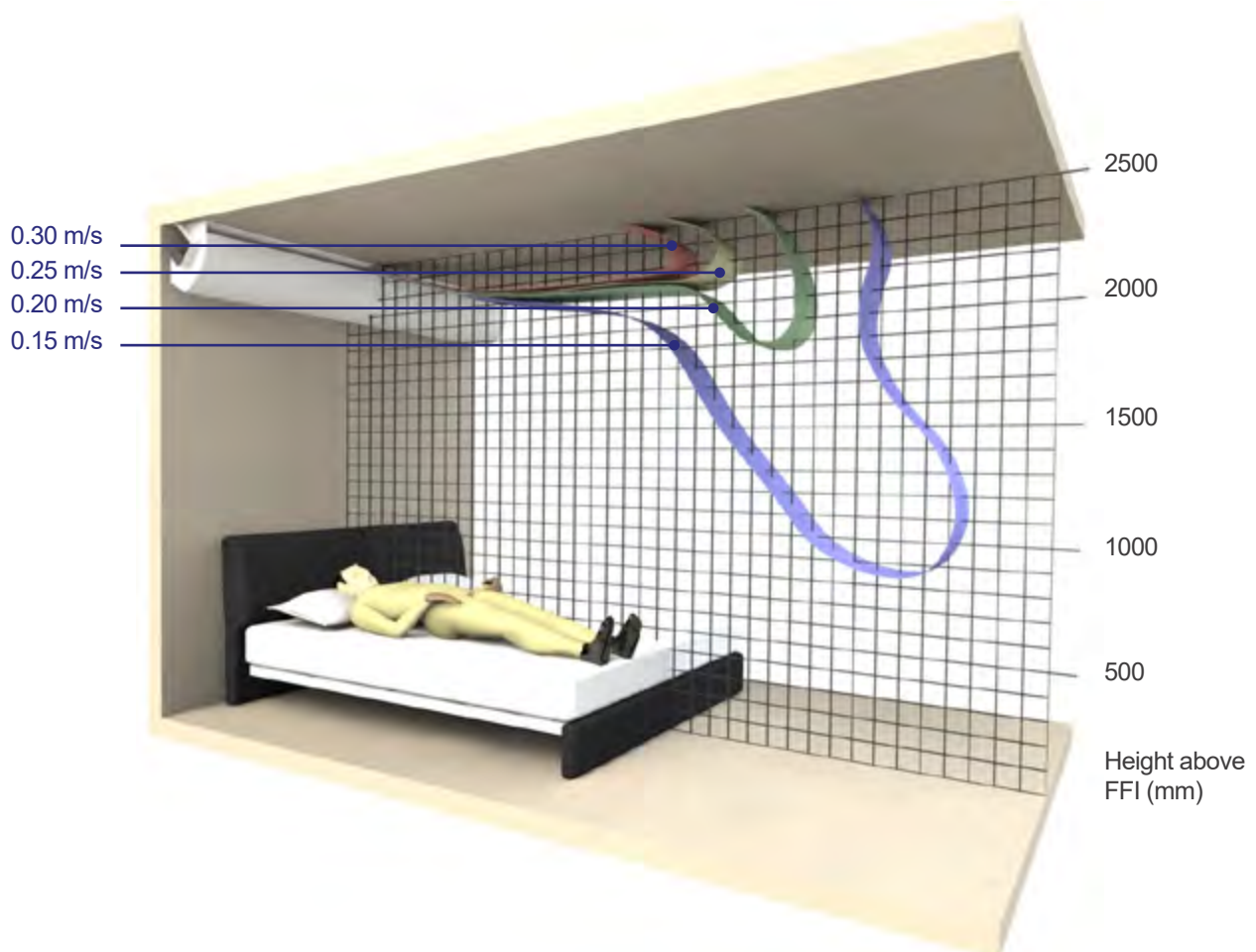

Electric Radiant Heating

Electric Radiant Heating Option

Electric radiant heating is an available upgrade to the Cornice Chilled Beam unit. This option is available to any model options, be it in conjunction with condensation drip tray and / or LED light options. The width of the Cornice unit does however increase by 100mm from the standard Cornice unit if electric radiant heating is chosen and the front fascia needs to be solid (not perforated) - see Fig 1.1 page 12 for details and page 15 for dimensions.

The removable front fascia of the Cornice unit is activated by an IP55 rated electric heating foil film applied to the inside of the fascia. Although IP55 is water jet resistant the electrical supply connection by the installer MUST incorporate a 30mA residual current device (RCD).

The surface temperature of the front fascia can reach upto 100°C and can yield the equivalent of 800 watts/m², see available heating table for the different Cornice™ unit lengths available.

Important Note: When calculating your room heat losses, be mindful of the cooling effect from the supply air, and if supply air temperature is lower than the intended room condition in heating mode.

Available Heating			
Beam Length (m)	Heating Capacity (W)	Voltage (V)	Surface Temp (°C)
1.5	525	230	Up to 100°C
2.0	700	230	Up to 100°C
2.5	875	230	Up to 100°C
3.0	1050	230	Up to 100°C



Fig 1.1

Cornice unit with Electric Radiant and LED Lighting - standard width plus 100mm if radiant heating option chosen in addition to lighting - see page 15 for dimensions.

Perforation Pattern Options

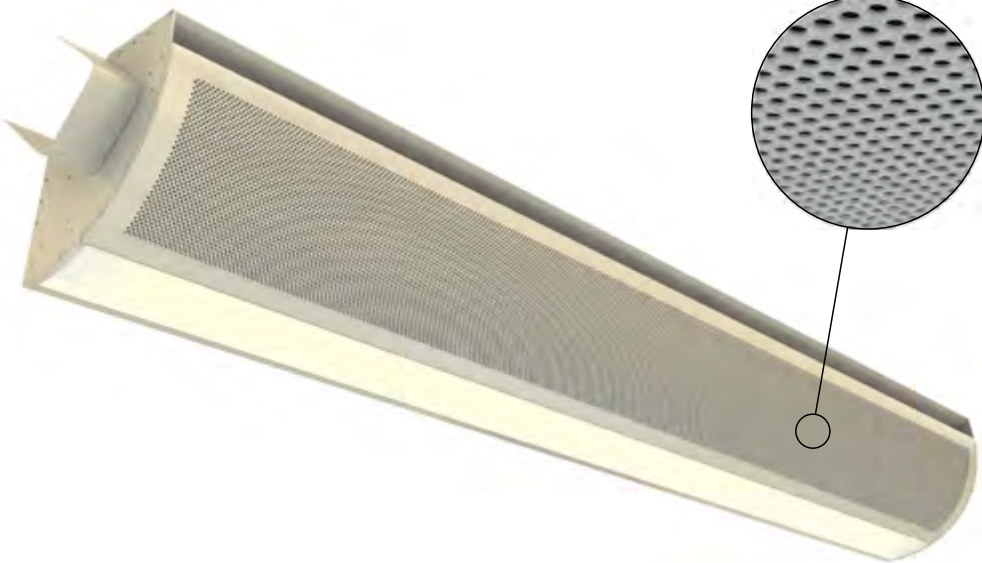

Dot Perforation
33% Free Area



Slot Perforation
45% Free Area

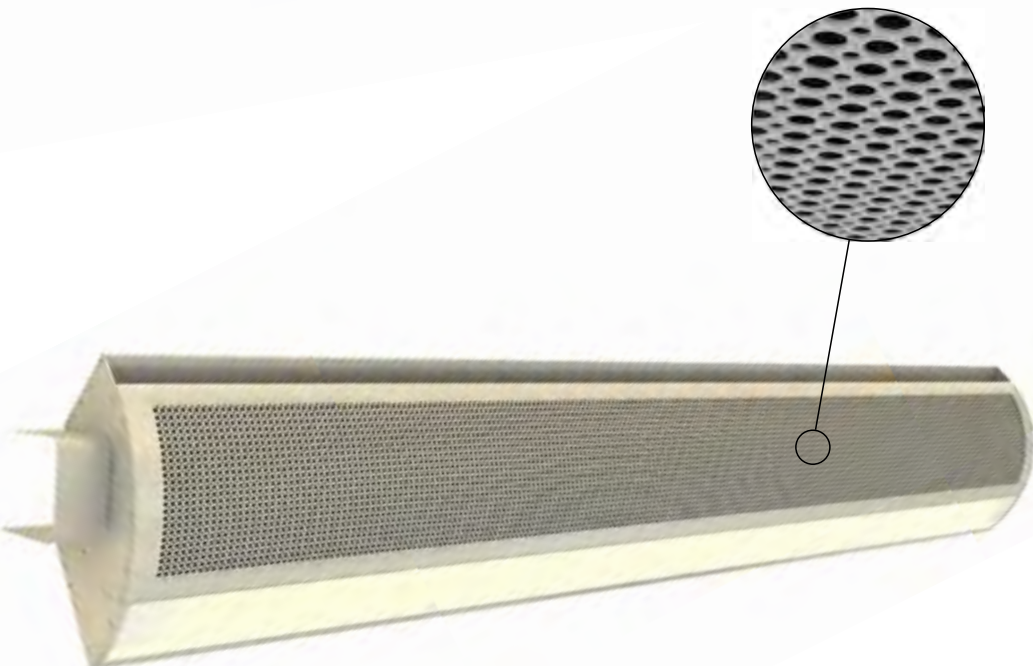

Double Dot Perforation
50% Free Area

Lighting Options

Integrated LED Lighting



LED lighting can be integrated into Frenger's Cornice™ Chilled Beam to provide a constant wash of light (that can be colour changing LED's if so desired) or just one end section or both end sections illuminated as reading lights. White LED colour temperatures 2700, 3000, 4000 and 6000k available.

Maintenance of the luminaires is greatly reduced given the long life expectancy of LED lighting as opposed to other forms of lighting. All LED luminaires factory fitted by Frenger are 100% tested for electrical safety and functionality in accordance with BS 60598-1 prior to packaging and dispatch of the Cornice™ Chilled Beam unit.

Tests include:

- Earth Continuity Test.
- Insulation Resistance Test.
- Polarity Check.
- Function Test.

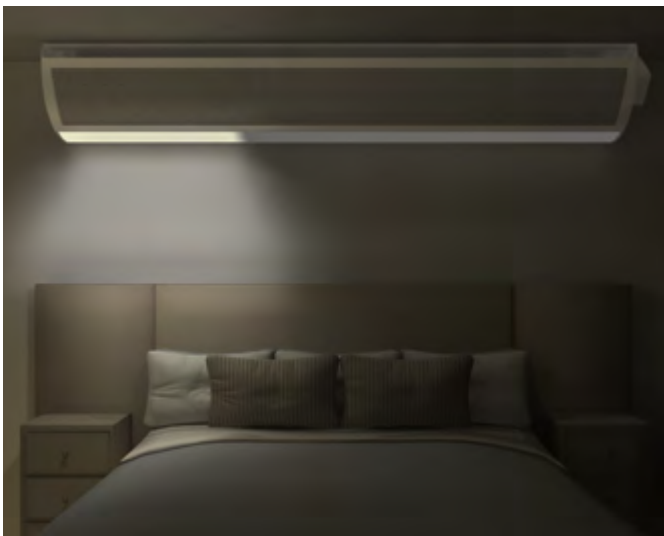

Condensation Outlet

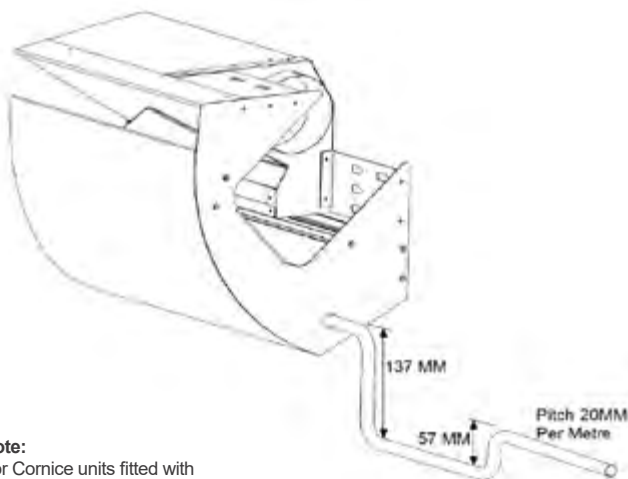

Note:
For Cornice units fitted with condensation drip trays the product width is standard width plus 25mm. See fig 1.3 on page 15.

The condensation outlet should be connected to a soil stack or foul water system. Usually connection ends would be at the bathroom side wall when installed in a hotel application.

Ensure that when connecting to the condensation outlet the installation pipe work has a gradient of at least 20mm fall per meter away from the connection end from the chilled beam condensate outlet. Also, it is good practice to form a water trap as recommended in the diagram opposite.

The use of Biocide tablets being used in the condensation tray / collection pan is also recommended to be used by the maintainer of the building systems as part of their planned maintenance as stagnant condensate accumulating in the collection pan / pipe work trap could provide habitat for various bacteria.

Product Dimensions

Standard Product

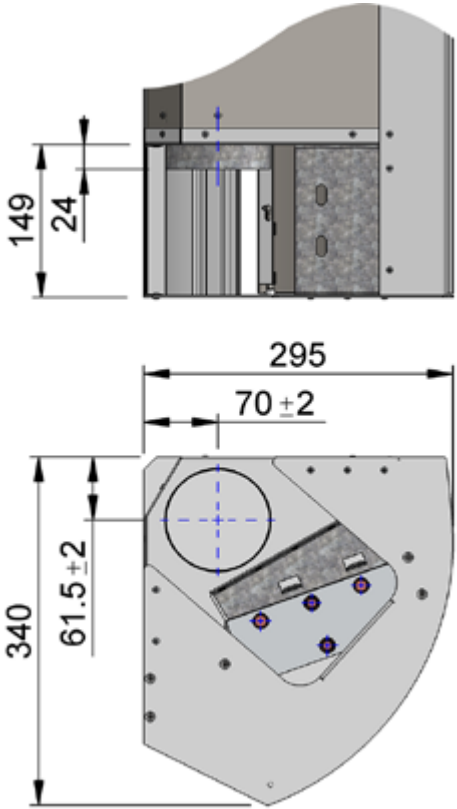

Fig 1.2

Cornice with Condensate Tray

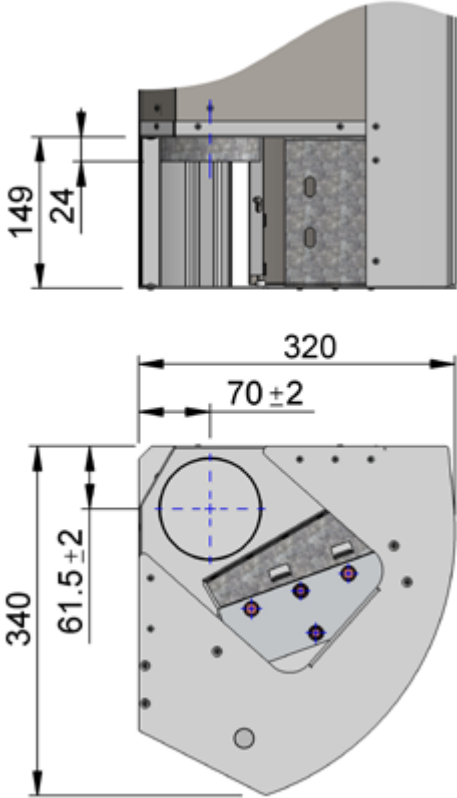

Fig 1.3

Cornice with Radiant Heating & Lighting
(and condensation tray if applicable)

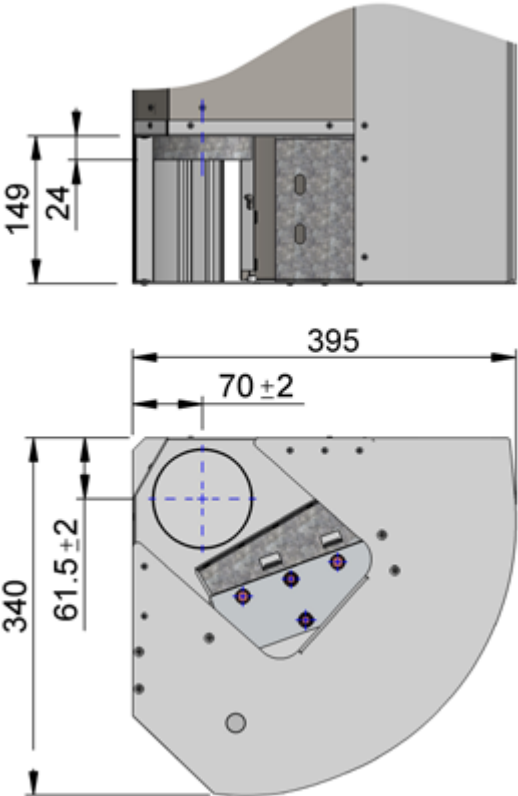
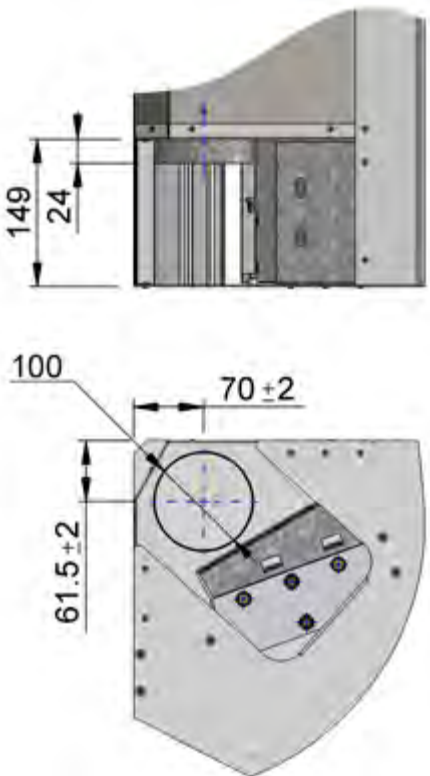
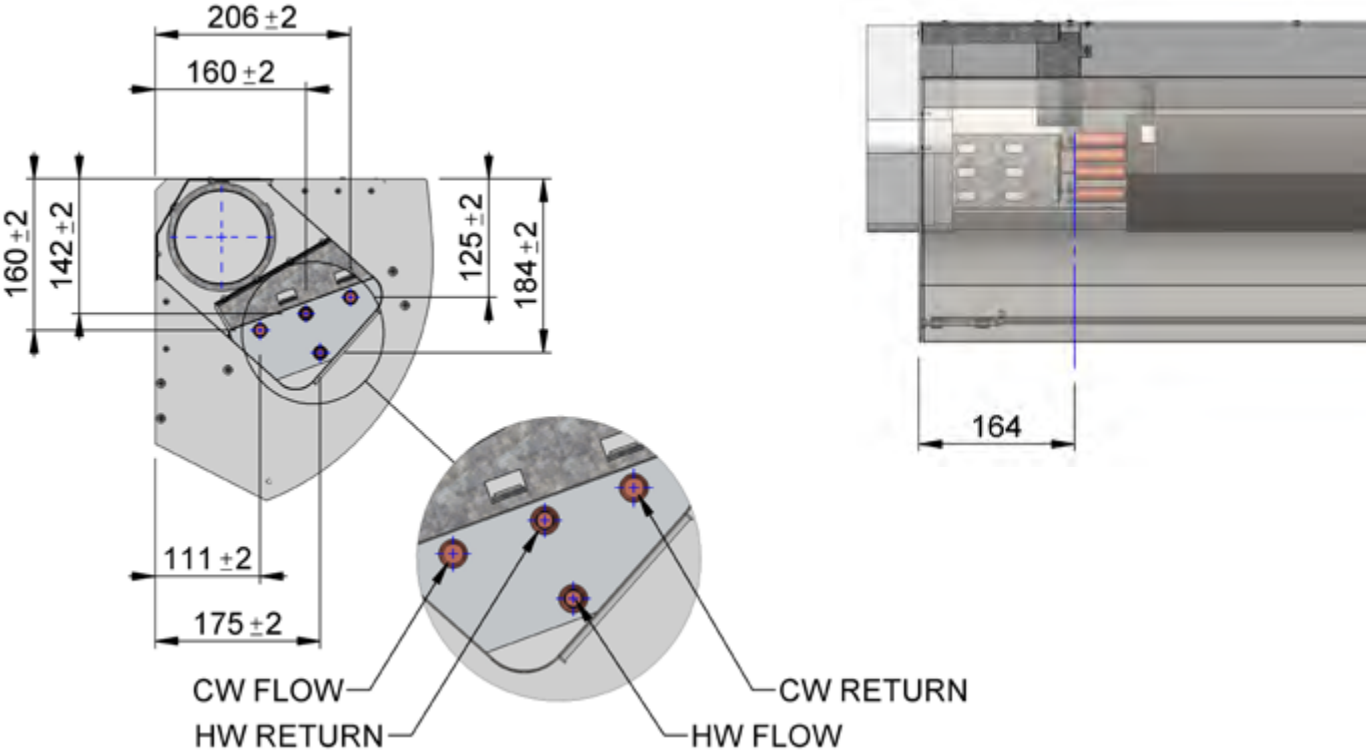

Fig 1.4

Air Connection



Water Connection



Note: Standard model only

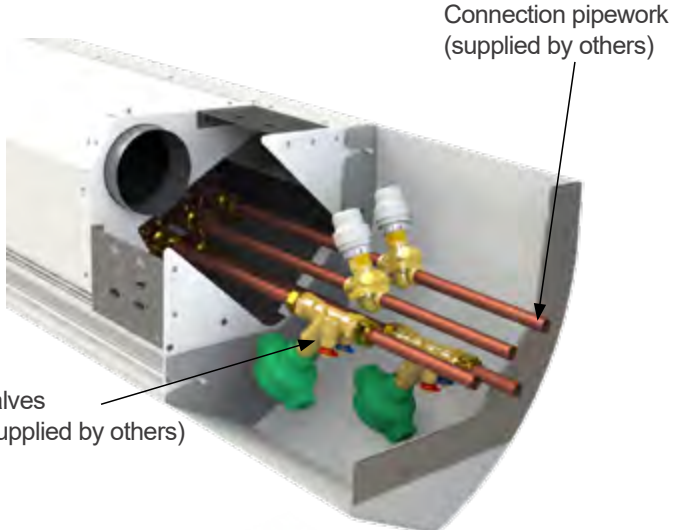
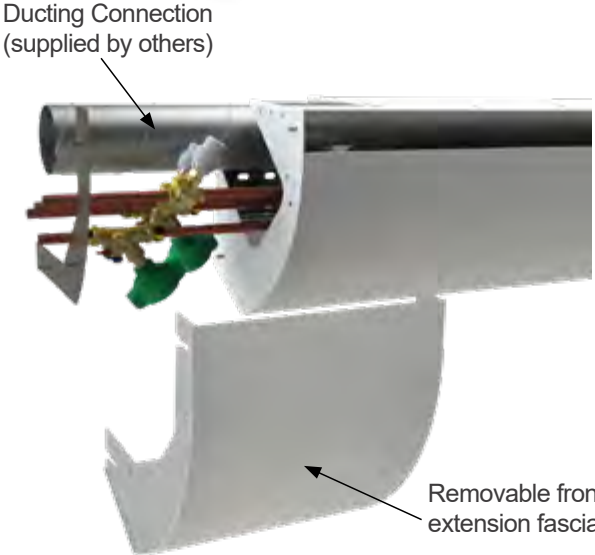
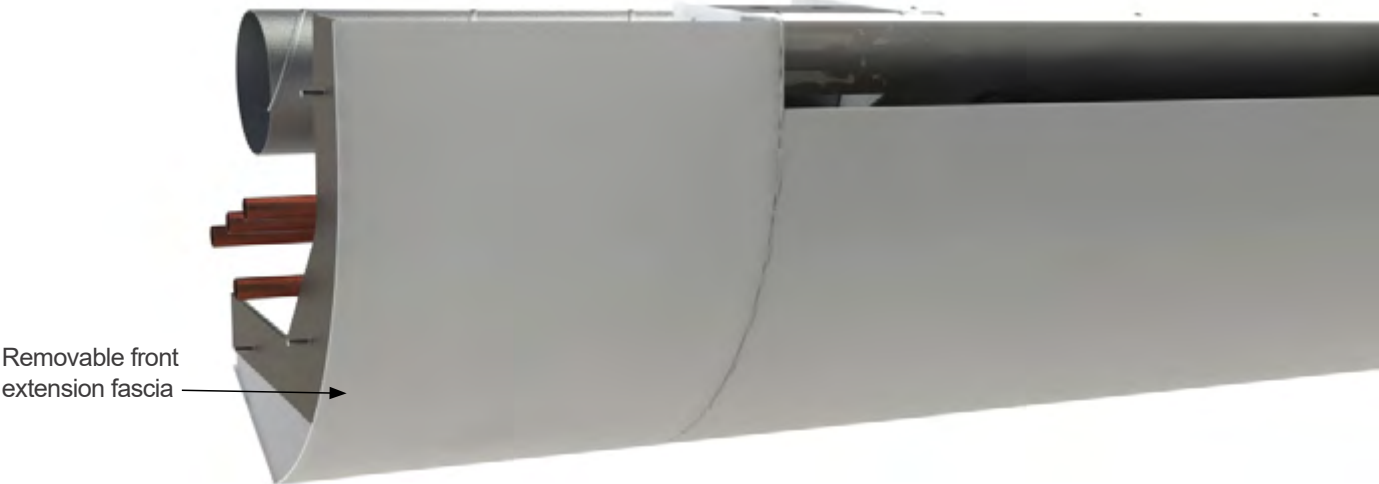

Mounting Details

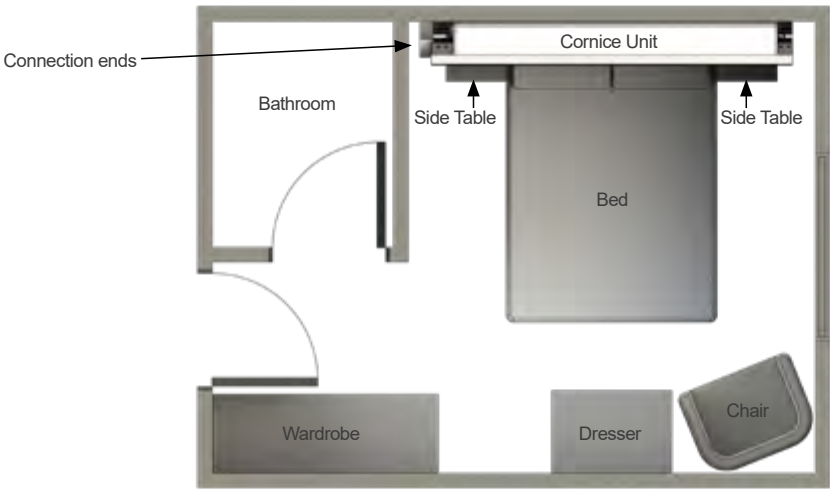

Suggested typical hotel room arrangement for connection ends.

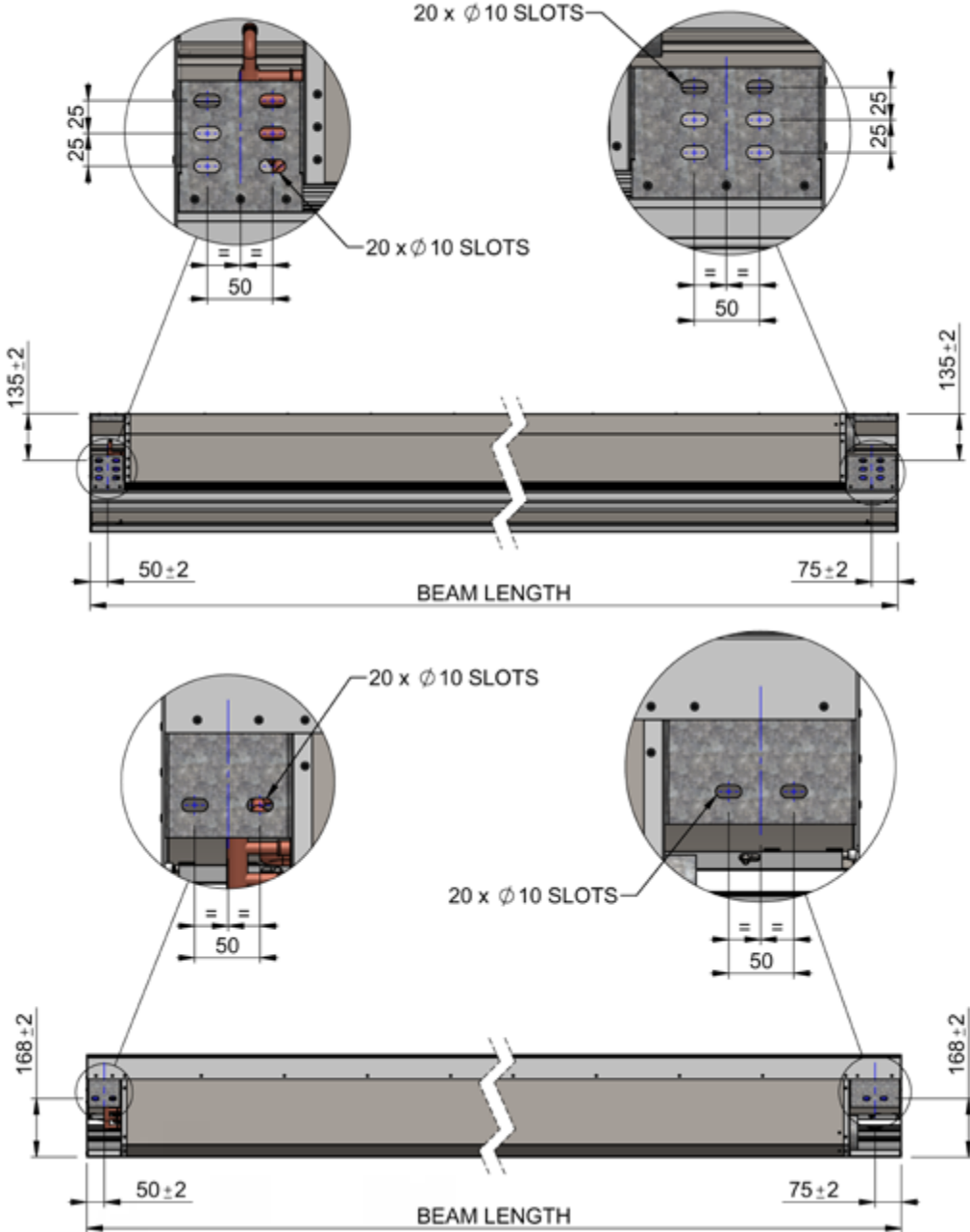

Note: Standard Cornice model only

Cornice Connection Covers

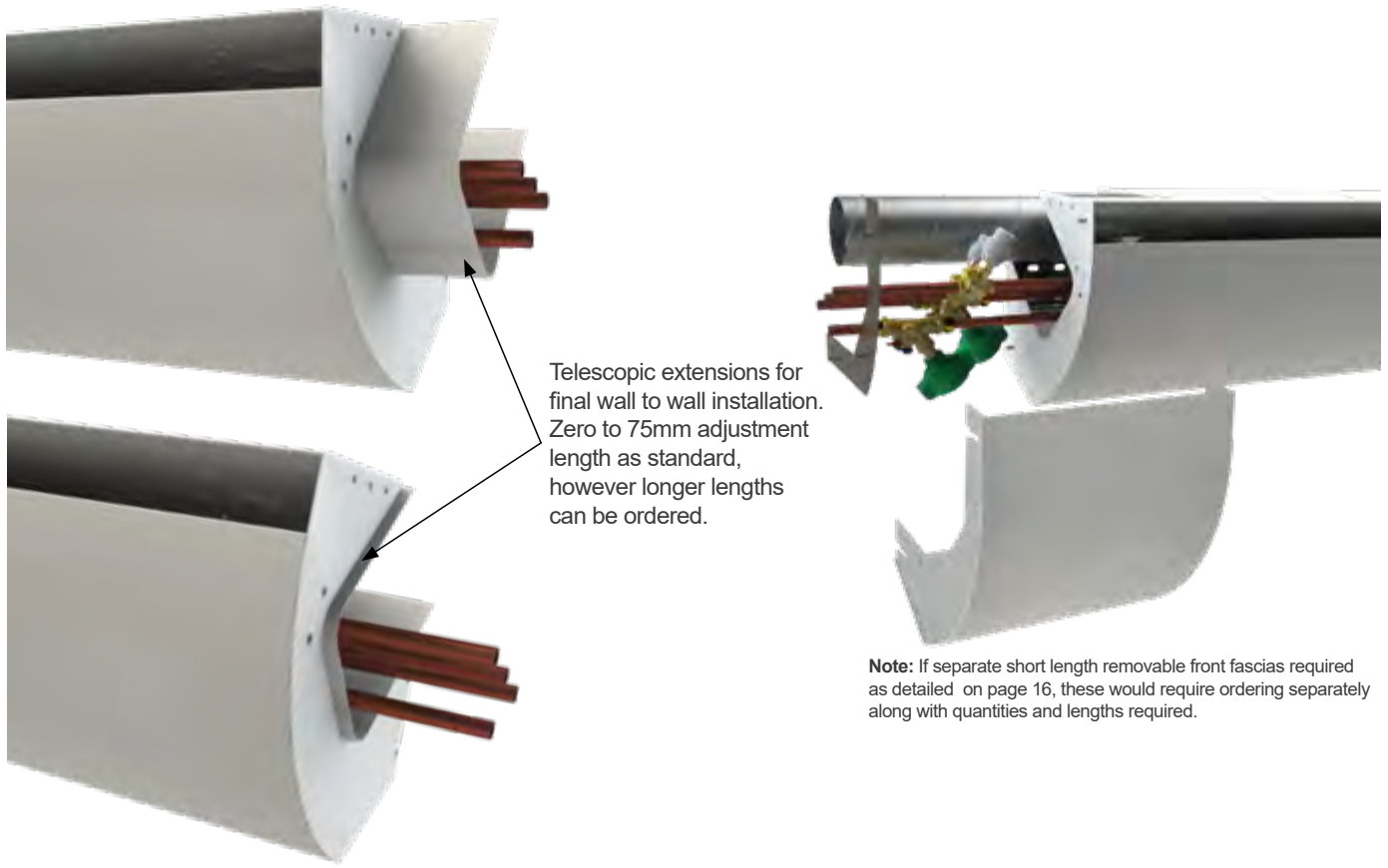

Note: Graphical representation of Cornice Standard Model. Cornice model dimensions vary - please see page 15 for details.

Product Ordering Codes

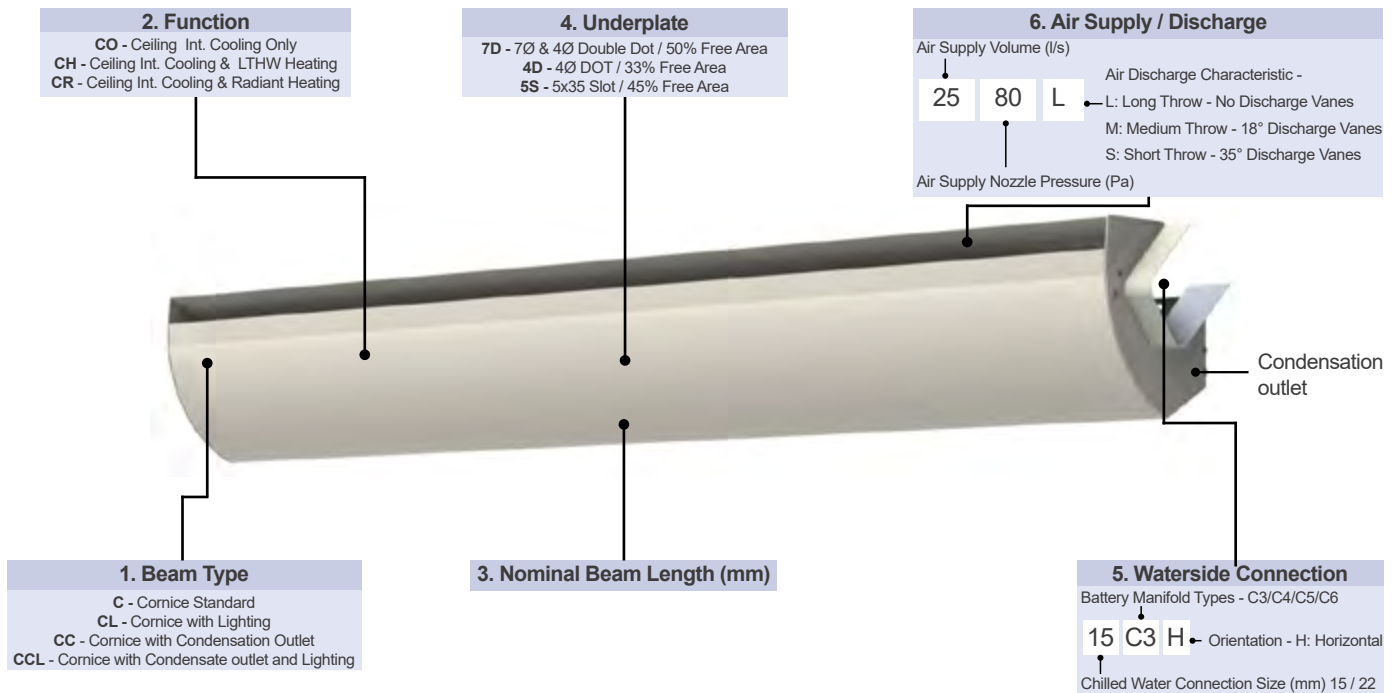

Example:

C	CH	2400	7D	-H	15C3H	2580L
1	2	3	4		5	6

Calculation Program

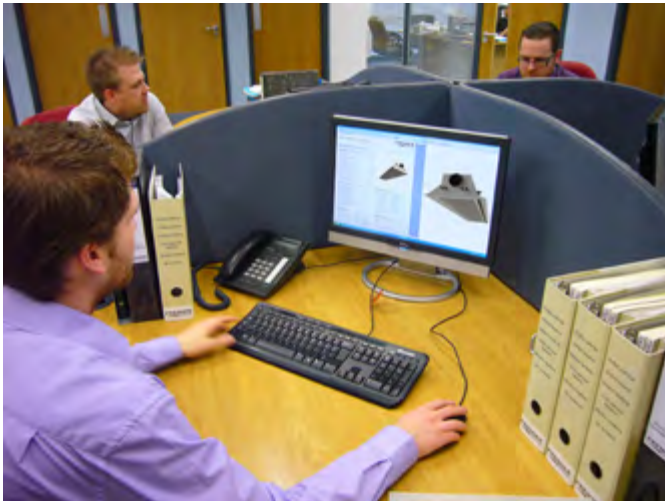

Cornice Active Beam Data

Air Connection	1x100 mm
Product Overall Length	2.4 m
Manifold Type	C4
Air Discharge Throw	L
Nozzle Static Pressure	100 Pa
Fresh Air Supply Volume	20 l/s
LTHW Heating Function	Yes
Radiant Heating (Electric)	No
Lighting	No
Condensation Drain Outlet	No

Frenger's calculation program for Cornice is extremely user friendly.

"Manifold types" can be changed in the drop down menu for increased waterside cooling effect, however attention needs to be taken regarding resultant pressure drops (hydraulic resistance). If pressure drops need reducing, choose a higher numbered manifold (C5 being the highest and C2 being the lowest).

"Discharge Throw" can be S (short), M (medium) or L (long).

Active Chilled Beam Calculation Tool

[Is this the latest version?](#)

version 1.3.1

FRENGER
systems

Cornice Active Beam Data

Air Connection	1x100 mm
Product Overall Length	2.4 m
Manifold Type	C4
Air Discharge Throw	L
Nozzle Static Pressure	100 Pa
Fresh Air Supply Volume	20 l/s
LTHW Heating Function	Yes
Radiant Heating (Electric)	No
Lighting	No
Condensation Drain Outlet	No

Design Conditions

	Cooling	Heating
Flow Water Temperature	14.0 °C	50.0 °C
Return Water Temperature	17.0 °C	40.0 °C
Air Supply Temperature	16.0 °C	19.0 °C
Average Room Condition	24.0 °C	21.0 °C
"Air On" Thermal Gradient	0.5 °C	
Room Relative Humidity	45.0 %	

Dimensional Data

Width x Depth	292 x 210 mm
Overall Length	2392 mm
Water Volume	1.7 l
Dry Weight	28.7 kg
CW Connection	Ø15 mm
LTHW Connection	Ø15 mm

Performance Data

	Cooling	Heating
Room - Mean Water dT	8.50 K	24.00 K
Air On Coil - Mean Water dT	8.96 K	21.00 K
Waterside Performance	562 W	447 W
Water Mass Flowrate	0.045 kg/s	0.011 kg/s
Waterside Pressure Drop	1.8 kPa	1.1 kPa
Airside Performance	203 W	-96 W
Total Sensible Performance	765 W	351 W
Sound Effect LW	< 35 dB(A)	

Design Check (Warnings)

Supply Air OK

Cooling Circuit OK

Heating Circuit OK

Turn Down Vol @ 40Pa 12.7 l/s

Calculated Dew Point 11.3 °C

Model Ref: C-CH2400-1x100H15C4H-2080L

Notes:
1) Performance calculations are based upon normal clean potable water, it is the system engineer's responsibility to allow for any reduction in cooling or heating performance due to additives that may reduce the water systems heat transfer coefficient.
2) Pressure drop calculations are based upon CIBSE guides using clean potable water and exclude any additional losses associated with entry / exit losses, pipe fouling or changes in water quality, it is the system engineer's responsibility to use good engineering practice.

Design Conditions

	Cooling	Heating
Flow Water Temperature	14.0 °C	50.0 °C
Return Water Temperature	17.0 °C	40.0 °C
Air Supply Temperature	16.0 °C	19.0 °C
Average Room Condition	24.0 °C	21.0 °C
Thermal Gradient	0.5 °C	
Room Relative Humidity	45.0 %	

Complete your project data in the "Design Conditions" section. Please note that the "Air On" Thermal Gradient should not be used in normal instances unless placed above a window - seek technical advice from Frenger.

Performance Data

	Cooling	Heating
Room - Mean Water dT	8.50 K	24.00 K
Air On Coil - Mean Water dT	8.96 K	21.00 K
Waterside Performance	562 W	447 W
Waterside Mass Flowrate	0.045 kg/s	0.011 kg/s
Waterside Pressure Drop	1.8 kPa	1.1 kPa
Airside Performance	203 W	-96 W
Total Sensible Performance	765 W	351 W
Sound Effect LW	<35 dB(A)	

"Performance Data" will then be automatically be calculated. Likewise "Dimensional Data" will be also automatically calculated.

Finally, the "Design Check" should read "OK" in green, or detail some warnings in red.

Calculation programs for Cornice are available upon request.

Contact our technical department or complete an application request from www.frenger.co.uk from the relevant link on our home page.

Bespoke Manufacturing

The Company has the manufacturing capability required to deliver the most complex of bespoke solutions. Facilities include the latest full CNC bending centers and machining equipment, together with a dedicated powder-coat paint plant to paint all of the components of the Multi-Service Chilled Beam.



Project Specific Testing Facility

The 3 number state-of-the-art Climatic Testing Laboratories at Frenger's technical facility in Derby (UK) have internal dimensions of 6.3m (L) x 5.7m (W) x 3.3m (H) high and includes a thermal wall so that both internal and perimeter zones can be simulated. Project specific testing validates product / solution performance (outputs) and resultant Room Comfort Conditions for compliance category grading in accordance with BS EN ISO 7730. All of Frenger's chilled beams have also been independently tested and certified by Eurovent in terms of product performance (output), as Eurovent can not test for thermal comfort; hence the need for Frenger's own laboratories.

Project Specific Testing

Project specific mock-up testing is a valuable tool which allows the Client to fully assess the proposed system and determine the resulting room occupancy Thermal Comfort conditions. The physical modelling is achieved by installing a full scale representation of a building zone complete with internal & external heat gains (Lighting, Small Power, Occupancy & Solar Gains).

The installed mock-up enables the client to verify the following:

- Product performance under project specific conditions.
- Spatial air temperature distribution.
- Spatial air velocities.
- Experience thermal comfort.
- Project specific aesthetics.
- Experience lighting levels (where relevant).
- Investigate the specific design and allow the system to be optimised.



The project-specific installation and test is normally conducted to verify:

- Product capacity under design conditions.
- Comfort levels - air temperature distribution.
 - thermal stratification.
 - draft risk.
 - radiant temperature analysis.
- Smoke test video illustrating air movement.
- Live Thermal Imaging

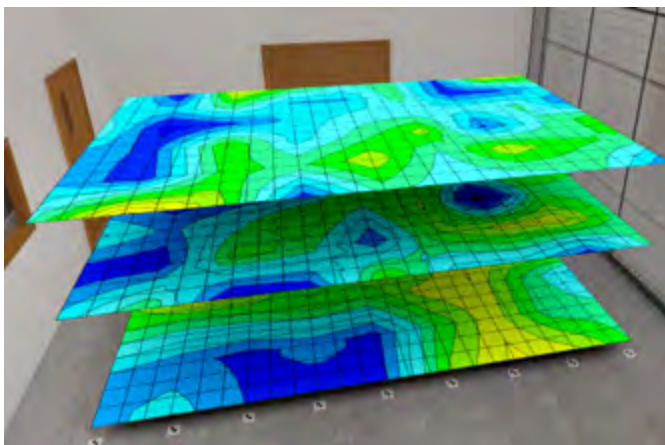
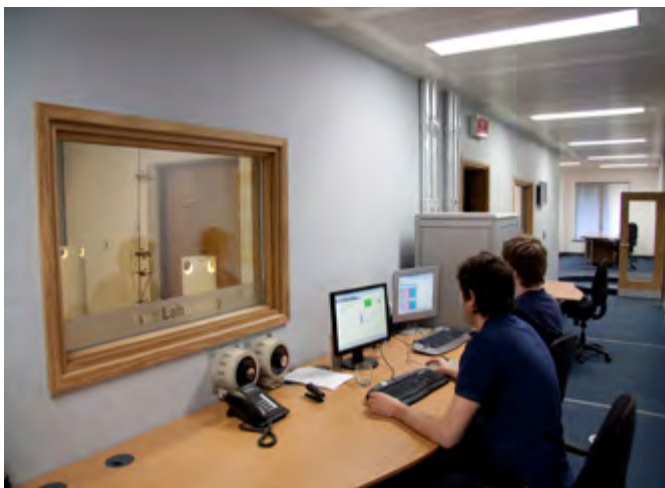

Photometric Testing Facility

The in-house Photometric test laboratories at Frenger are used to evaluate the performance of luminaires. To measure the performance, it is necessary to obtain values of light intensity distribution from the luminaire. These light intensity distributions are used to mathematically model the lighting distribution envelope of a particular luminaire. This distribution along with the luminaires efficacy allows for the generation of a digital distribution that is the basis of the usual industry standard electronic file format. In order to assess the efficacy of the luminaire it is a requirement to compare the performance of the luminaire against either a calibrated light source for absolute output or against the “bare” light source for a relative performance ratio.

The industry uses both methods. Generally absolute lumen outputs are used for solid state lighting sources and relative lighting output ratios (LOR) are used for the more traditional sources. Where the LOR method is chosen then published Lamp manufacturer’s data is used to calculate actual lighting levels in a scheme and for LED light source the integration chamber is used to measure LED luminance efficacy.

The intensity distribution is obtained by the use of a Goniophotometer to measure the intensity of light emitted from the surface of the fitting at pre-determined angles. The light intensity is measured using either a photometer with a corrective spectral response filter to match the CIE standard observer curves or our spectrometer for LED sources.

Luminaire outputs are measured using our integrating sphere for smaller luminaires or our large integrator room for large fittings and Multi Service Chilled Beams. For both methods we can use traceable calibrated radiant flux standards for absolute comparisons.

All tests use appropriate equipment to measure and control the characteristics of the luminaire and include air temperature measurements, luminaire supply voltage, luminaire current and power. Thermal characteristics of luminaire components can be recorded during the testing process as required.

A full test report is compiled and supplied in “locked” PDF format. Data is collected and correlated using applicable software and is presented electronically to suit, usually in Eulumdat, CIBSE TM14 or IESN standard file format.

Frenger conduct photometric tests in accordance with CIE 127:2007 and BS EN 13032-1 and sound engineering practice as applicable. During the course of these tests suitable temperature measurements of parts of LED’s can be recorded. These recorded and plotted temperature distributions can be used to provide feedback and help optimise the light output of solid state light source based luminaires which are often found to be sensitive to junction temperatures.

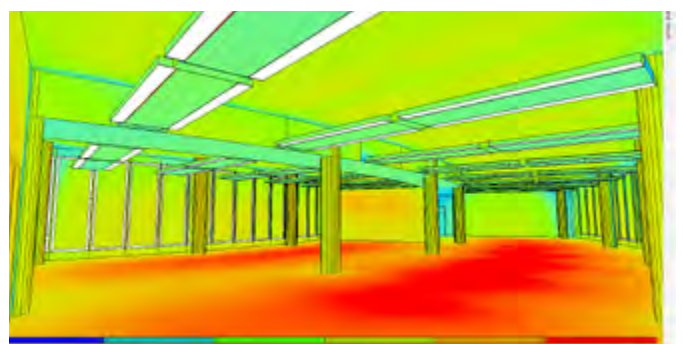
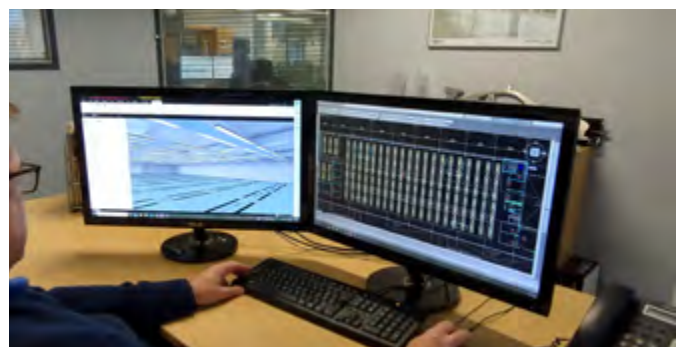
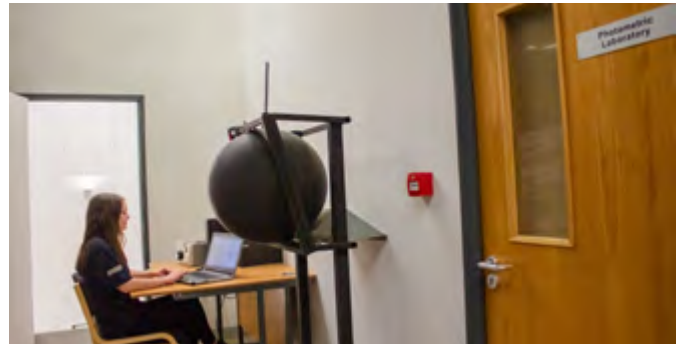

Acoustic Testing Facility

The Acoustic Test Room at Frenger is a hemi-anechoic chamber which utilises sound absorbing acoustic foam material in the shape of wedges to provide an echo free zone for acoustic measurements; the height of the acoustic foam wedge has a direct relationship with the maximum absorption frequency, hence Frenger had the acoustic wedges specifically designed to optimise the sound absorption at the peak frequency normally found with our active chilled beam products.

The use of acoustic absorbing material within the test room provides the simulation of a quiet open space without “reflections” which helps to ensure sound measurements from the sound source are accurate, in addition the acoustic material also helps reduce external noise entering the test room meaning that relatively low levels of sound can be accurately measured.

The acoustic facilities allow Frenger to provide express in-house sound evaluation so that all products, even project specific designs can be quickly and easily assessed and optimised.

To ensure accuracy, Frenger only use Class 1 measurement equipment which allows sound level measurements to be taken at 11 different $\frac{1}{3}$ octave bands between 16 Hz to 16 kHz, with A, C and Z (un-weighted) simultaneous weightings.

In addition to the above, Frenger also send their new products to specialist third party Acoustic Testing. The results of which are very close and within measurement tolerances to that of Frenger’s in-house measurement of sound.

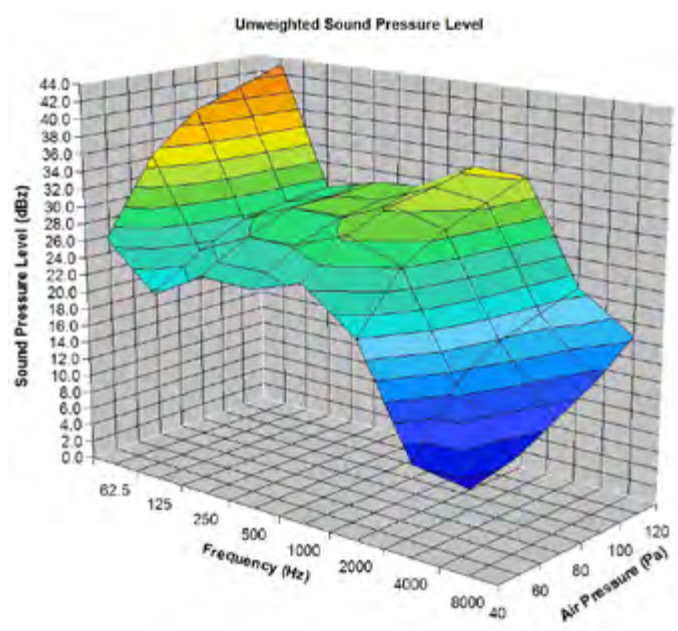
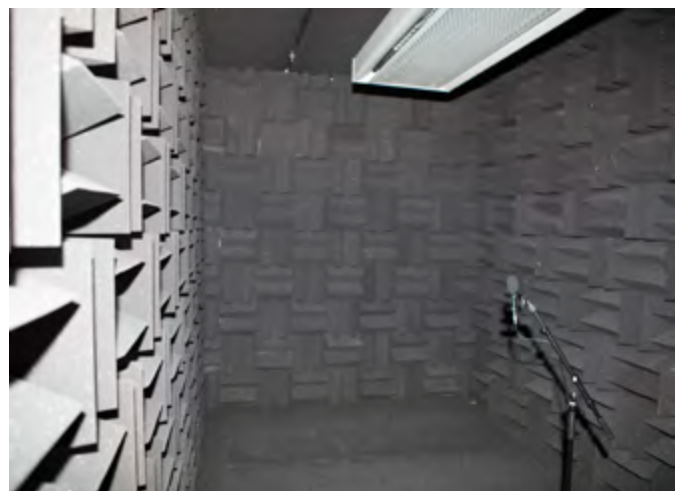
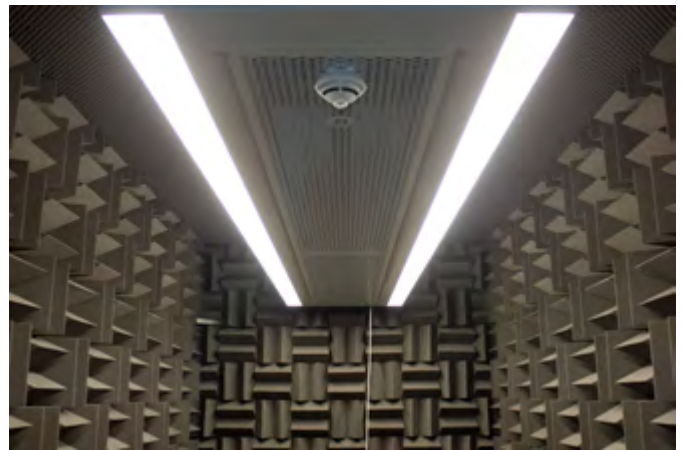





Frenger Systems participates in the ECC program for Chilled Beams. Check ongoing validity of certificate: www.eurovent-certification.com or www.certiflash.com 



UK Head Office

Frenger System Ltd
Riverside Road
Pride Park
Derby
DE24 8HY

tel: +44 0 1332 295 678
sales@frenger.co.uk
www.frenger.co.uk

Australian Office

Frenger
Level 20
Tower 2
201 Sussex Street
Sydney
NSW 2000
Australia

tel: +61 2 9006 1147
sales@frenger.com.au
www.frenger.com.au

American Office

FTF Group Climate
Bryant Park
104 W40th Street
Suite 400 & 500
New York
NY 10018
United States of America

tel: +00 1 (646) 571-2151
sales@ftfgroup.us
www.ftfgroup.us



Frenger is an FTF Group Company
Registered No. 646 6229 20

www.frenger.co.uk